

# PRODUCT SHEET

## Description:

Cushion "B" F/SS Clamp "Oval-L", Glass 6mm (6,32mm), Black EPDM

## Item number:

22.10.629-0

Units	Box	Carton	HS Code	Barcode
Pcs.	8	1000	4016930090	 5704866476645

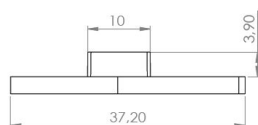
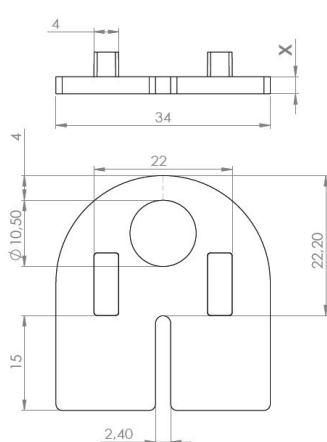

Hardness Shore A = 65 +/- 3

Item:	X (+/- 0,1)	f. glass thickness
22.10.624-6	2,90	12,76
22.10.624-5	3,20	12,00
22.10.624-0	3,75	10,76
22.10.625-0	4,23	10,00
22.10.626-0	4,80	8,76
22.10.627-0	5,25	8,00
22.10.628-0	5,80	6,76
22.10.629-0	6,32	6,00

## SISO A/S

Mileparken 11  
DK-2740 Skovlunde  
Denmark  
VAT: DK 24786013

Phone +45 45 830 900

www.siso.dk  
siso@siso.dk

Danske Bank  
Nytorv Branch  
Copenhagen  
SWIFT: DABADKKK

Account no.  
4180 3112 112936  
IBAN Account  
DK7230003112112936